

heinrich

# PRODUCTION BENCH VISE

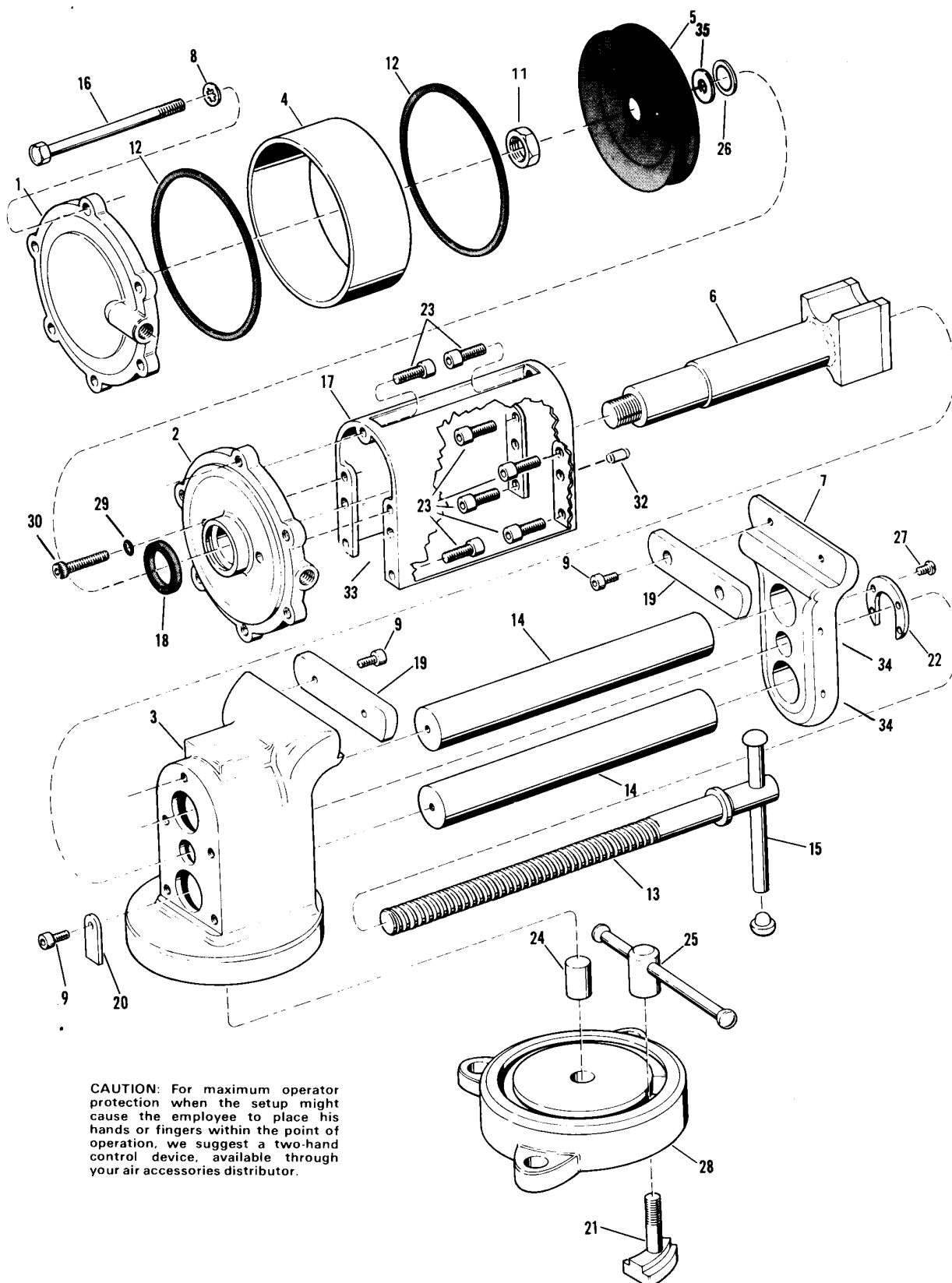

**CAUTION:** For maximum operator protection when the setup might cause the employee to place his hands or fingers within the point of operation, we suggest a two-hand control device, available through your air accessories distributor.

## MODEL 14

Index No.	Part Name	Part No.	Price
1	Cylinder Head Casting	8800-1	\$82.23
2	Cylinder Body Casting	14-2	94.88
3	Body Casting (Note 1)	14-3	--
4	Cylinder Tube	14-4	70.62
5	Piston Cup	8800-5	111.42
6	Draw Bar Weldment	14-6	102.40
7	Jaw Casting	14-7	72.11
8	5/16" Internal Tooth Lock Washer (6 required)	3301-9	0.24
9	1/4-20 x 1/2 Screw (5 required)	30-1/2	0.54
11	3/4-16 Jam Nut	6601-11	1.77
12	Cylinder Gasket (2 required)	8800-12	4.82
13	Screw	14-13	43.55
14	Guide Bar (2 required)	14-14	61.60
15	Handle, with two buttons	2315	3.53
16	5/16-18 x 4 Screw (6 required)	3301-15	1.41
17	Shroud Casting	14-17	96.14
18	1 1/4 U-Packing	8800-18	4.71
19	Jaw Inserts, hardened (set of 2)	14-19	34.50
20	Bar Stop	14-20	1.18
21	T-Bolt (2 required)	14-21	16.48
22	Washer	14-22	8.24
23	5/16-18 x 3/4 Screw (8 required)	33-8	0.47
24	Pivot Stud	H-62	1.65
25	Swivel Clamp Assembly (2 required)	14-25	14.12
26	Stat-O-Seal	600-3/4	2.61
27	1/4 -20 x 1/2 Screw (4 required)	2200-42	0.47
28	Swivel Base Casting	14-28	94.88
29	O-Ring-- ARP568A-011 (2 required)	14-31	0.81
30	5/16-18 x 1 1/4 (2 required)	6619-1	0.36
32	1/4 x 5/8 Rollpin (4 required)	45-10	0.94
33	Cover Plate (not shown)	14-33	2.94
34	3/8-24 x 1/2 (required) (not shown)	14-34	0.47
35	Back-up Washer	6601-5A	4.71

**Note 1:** Price not shown, as replacement body castings are not available.

Recommended spare parts to be retained in stock at all times to support each unit in service: Index (5) Piston Cup, Index (12) Cylinder Gasket, Index (18) U-Packing.

### WHEN ORDERING PARTS, INDICATE PART NUMBER, MODEL NUMBER AND PRICE.

#### OPERATION:

Connect one of the three identical hoses to the air supply line and to the adapter on the four-way valve marked "IN." Connect the other two hoses to the two adapters on the four-way valve marked "CYL" (cylinder) and to the two adapters on the cylinder.

Heinrich air units can be used safely on air supply lines with pressures up to 120 psi.

Adjust jaw (7) to required opening by means of handle (15), like an ordinary bench vise, allowing minimum travel under air pressure to provide sufficient clearance to remove and insert workpiece.

The range of holding power can be controlled by installing an Air Regulator between the air supply line and the four-way valve. While all operating parts are protected from oils, coolants, chips, etc., the air cylinder and controls could be damaged by foreign matter in the

air line. This can be prevented by using an Air Filter, between the air supply and the air regulator and/or control valve. A Combination Filter-Regulator may be used in place of the separate filter and regulator.

#### MAINTENANCE:

An occasional oiling of the guide bars and adjusting screw is recommended. If the vise becomes inoperable, disassemble as shown in exploded view. Clean and check each part for wear or damage. Replacement parts are available for immediate shipment from factory stock, or you may order through your local Heinrich distributor. When reassembling, all screws and nuts should be evenly and securely tightened.