

DRFT SERIES FOURTH AXIS ROTARY TABLES



Model DRFT-320 with Fanuc AC servo motor



Model 5CA-2 with Sanyo AC servo motor



Model 220 with digital AC servo motor



Model 220 with Kollmorgen motor
& rear motor mount kit

NOTE: Call for overall dimensional specifications for rotary tables using rear mounted motors.

- ▶ Compatible with most popular AC servo motors. Fanuc, Mitsubishi, Yaskawa, etc.
- ▶ New spindle disc brake design with up to **40%** more holding force.
- ▶ Pressure switches provide trouble free brake operation.
- ▶ Internal harness provided with each rotary table, (external harness optional.)
- ▶ 100 VAC (Std.) or 24 VDC solenoid valve supplied.
- ▶ Hardened and ground spur gear drive.
- ▶ Double lip oil seal, for **maximum** protection against coolant contamination.
- ▶ New worm shaft housing design, with dual needle and thrust bearings for anti-backlash.
- ▶ Dual main casting grooves with "O"-rings, for the **utmost defense** from contamination reaching the motor.
- ▶ Home position and over-travel limit switches provided.

Standard external harness (optional): PN# MCBE-FA includes: 2 cable set (16 ft.) and Amphenol MS connections on both sides of cable.

- ▶ Table body, with motor cover for AC servo motors.
- ▶ 100 VAC (Std.) or 24 VDC solenoid valve and pressure switch for pneumatic spindle brake.
- ▶ Internal harness (cables from motor and encoder to inner shell of motor cover).
- ▶ All cables and motor covers are supplied with Amphenol brand connectors.
- ▶ Hardened and ground spur gears from motor to worm shaft (tapered type).
- ▶ Limit switch for home position (N/C (Std.) or N/O).
- ▶ Warranty card, test report, electrical drawings and operator's manual.

MOST MOTORS CAN BE ACCOMODATED INCLUDING:

FANUC	SIEMENS
YASKAWA	VICKERS
MITSUBISHI	KOLLMORGEN
GLENTech	S.E.M.
BALDOR	SANYO
and many others!	

SPECIAL NOTE: motor is not included, but can be supplied at additional cost. Mounting of the motor is included in the cost of the table.



MODEL 220 w/8" chuck
and adapter plate



MODEL 220 w/8" air chuck
and adapter plate

Inch/(mm)

MODEL / DRFT	DRFT 130	DRFT 170	DRFT 220	DRFT 280	DRFT 320	DRFT 400	DRFT 500	DRFT 630	DRFT 800
SUB TABLE									
O.D.	5.12 (130)	6.69 (170)	8.66 (220)	11.02 (280)	12.60 (320)	15.75 (400)	19.68 (500)	24.80 (630)	31.50 (800)
I.D BORE	1.18 (30)	1.65 (42)	1.65 (42)	1.65 (42)	1.65 (42)	1.65 (42)	N/A	N/A	N/A
I.D THREAD	N/A	M36 P3.0	M36 P3.0	M36 P3.0	M36 P3.0	M36 P3.0	N/A	N/A	N/A
CENTER HEIGHT	4.13 (105)	5.12 (130)	6.30 (160)	7.48 (190)	8.66 (220)	10.24 (260)	12.20 (310)	16.54 (420)	18.90 (480)
MAX RPM	75	41.6	33	16.6			11.1		
SPINDLE TORQUE ft-lbs (Kg-m)	228 (30.4)	240 (32)	300 (40)	950 (120)	950 (120)	1,400 (186)	1,950 (260)	2,700 (360)	3,250 (430)
SPINDLE BRAKE TORQUE ft-lbs (Kg-m)									
Pneumatic	40 (5)	110 (15)	180 (25)	325 (45)	480 (66)	N/A	N/A	N/A	N/A
Hydraulic	108 (115)	217 (30)	352 (49)	515 (71)	623 (86)	789 (109)	855 (118)	941 (130)	1,231 (170)
RESOLUTION (degrees)	0.00075"			0.001"			0.00025"		
MAX LOAD HORIZONTAL (TABLE POSITION) lbs (Kg)	66 (30)	180 (80)	260 (120)	400 (180)	550 (250)	660 (300)	2,156 (980)	3,300 (1,500)	4,400 (2,000)
MAX LOAD VERTICAL (TABLE POSITION) lbs (Kg)	33 (15)	90 (40)	130 (60)	200 (90)	275 (125)	330 (150)	1,045 (475)	1,430 (650)	1,650 (750)
POSITIONING ACCURACY	(+/-) 10 seconds						(+/-) 7.5 seconds		
REPEATABILITY	(+/-) 2 seconds								
MOTOR TYPE	Digital AC Servo Motor (Fanuc, Yasnac, Sanyo, Meldas, etc.) Please specify								
SETTING POSITION	Horizontal / Vertical								
THRU HOLE DIAMETER (spindle)	1.44 (36.5)	1.77 (45)	2.50 (63.5)	3.54 (90)	4.33 (110)	6.69 (170)	10.0 (254)	10.0 (254)	
SPINDLE RUNOUT	0.0006 (0.02)								
T-SLOTTED FACE PLATE	4 T-Slots	6 T-Slots				8 T-Slots			
GEAR RATIO	60 : 1	72 : 1	100 : 1	90 : 1	120 : 1	144 : 1	90 : 1		
SOLENOID TYPE	100 VAC (Std.) or 24 VDC								
LIMIT SWITCH CONDITION	N/C (Std.) or N/O								
BRAKE CONDITION	Solenoid is active or non-active when brake is on (specify)								
NET WEIGHT lbs (Kg)	70 (32)	108 (49)	180 (82)	282 (128)	418 (190)	682 (310)	1,131 (513)	1,815 (825)	2,750 (1,250)

ORDERING INSTRUCTIONS

Motor covers for Fanuc Alpha(i) drives are standard. Other servo drives (due to overall motor length) may require our motor cover extension (see page #16). Specify motor type and part number. The spur gears we provide are designed for AC servo motors with tapered shafts. Encoders can also be different. Our motor covers are long enough to house incremental, absolute and serial encoders. However, the internal harness can be different for each. Please specify encoder PN# if applicable. The Yuasa rotary tables are supplied with a solenoid valve and pressure switch for the spindle brake. We can supply either 100VAC (std.) or 24VDC. Please specify. In addition, we must know whether the solenoid is active or non-active when the brake is on. Indicate the condition of the home position limit switch, N/C or N/O.



DRFT SERIES DIMENSIONAL SPECIFICATIONS:

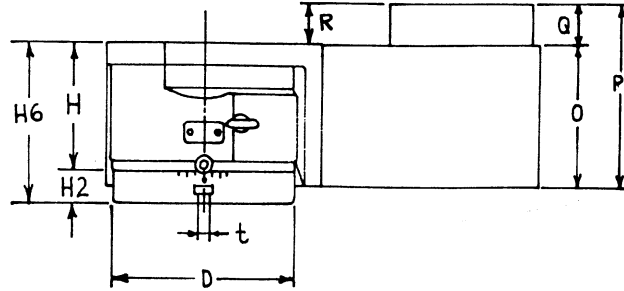
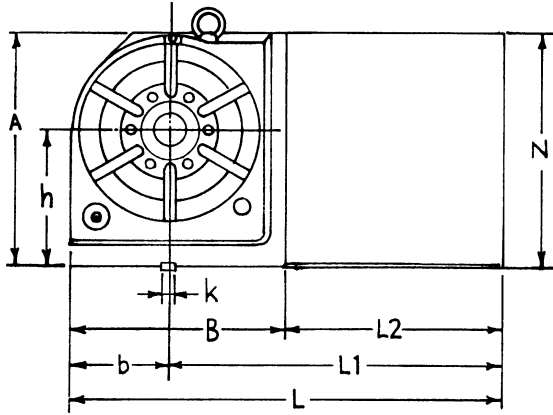

Overall dimensions

Inch/(mm)

MODEL	A	B	b	C	D	L	H	H2	H6	t	h	k	N	O	P	Q	R
DRFT-130	7.87 (200)	6.57 (167)	3.03 (77)	5.31 (135)	5.12 (130)	13.44 (341)	4.78 (121)	1.12 (28)	5.91 (150)	0.39 (9.9)	4.13 (105)	0.55 (14)					
DRFT-170	9.25 (235)	8.46 (215)	3.94 (100)	5.91 (150)	6.69 (170)	17.69 (449)	5.31 (135)	1.38 (35)	6.69 (170)	0.47 (12)	5.12 (130)	0.17 (18)	8.58 (218)	6.69 (170)	8.66 (220)	1.97 (50)	1.69 (43)
DRFT-220	11.02 (280)	10.24 (260)	4.72 (120)	6.89 (175)	8.66 (220)	19.86 (504)	6.18 (157)	1.5 (38)	7.68 (195)	0.47 (12)	6.30 (160)	0.71 (18)	11.02 (280)	6.69 (170)	8.66 (220)	1.97 (50)	1.77 (45)
DRFT-280	13.39 (340)	12.60 (320)	5.91 (150)	7.68 (195)	11.02 (280)	23.25 (590)	6.97 (177)	1.69 (43)	8.66 (220)	0.47 (12)	7.48 (190)	0.71 (18)	11.22 (285)	7.56 (192)	8.66 (220)	1.97 (50)	1.26 (32)
DRFT-320	15.35 (390)	14.45 (367)	6.69 (170)	8.66 (220)	12.6 (320)	26.28 (667)	7.76 (197)	1.89 (48)	9.65 (245)	0.55 (14)	8.66 (220)	0.71 (18)	11.81 (300)	7.85 (200)	8.66 (220)	1.97 (50)	0.79 (20)
DRFT-400	18.5 (470)	17.32 (440)	8.27 (210)	9.45 (240)	15.75 (400)	29.10 (739)	8.54 (217)	2.09 (53)	10.63 (270)	0.55 (14)	10.24 (260)	0.71 (18)	12.05 (306)	7.85 (200)	8.66 (220)	1.97 (50)	0.39 (10)

NOTE: Overall dimensions reflect Fanuc Alpha drives. Other motors may require motor cover extensions. For dimensional information on DRFT 500 ~ 800 see page 13.

Spindle Specifications

Inch/(mm)

MODEL	D1	d	d1	PCD-M	H1	H3	H4	H5	H7
130	4.01 (102)	2.76 (70)	1.44 (36.5)	2.36-M5 (60-M5)	0.18 (4.5)	0.65 (16.5)	1.81 (46)	0.63 (16)	7.87 (200)
170	6.57 (167)	3.35 (85)	1.77 (45)	2.44-M8 (62-M8)	0.28 (7)	0.71 (18)	2.68 (68)	1.79 (45.4)	10.49 (266.4)
220	8.27 (210)	4.33 (110)	2.50 (63.5)	3.54-M8 (90-M8)	0.31 (8)	0.79 (20)	2.95 (75)	1.84 (46.8)	11.76 (298.8)
280	10.79 (277)	5.51 (140)	3.54 (90)	4.57-M10 (116-M10)	0.35 (9)	0.87 (22)	3.58 (91)	2.13 (54.2)	13.55 (344.2)
320	12.2 (310)	6.30 (160)	4.33 (110)	5.35 - M10 (136 - M10)	0.35 (9)	0.98 (25)	3.78 (96)	2.28 (58)	14.8 (376)
400	15.16 (385)	7.48 (190)	5.12 (130)	6.30 - M10 (160-M10)	0.35 (9)	1.10 (28)	3.94 (100)	2.56 (65)	16.14 (410)

NOTE: Motor covers with cables directed out the end of the cover are available on request.

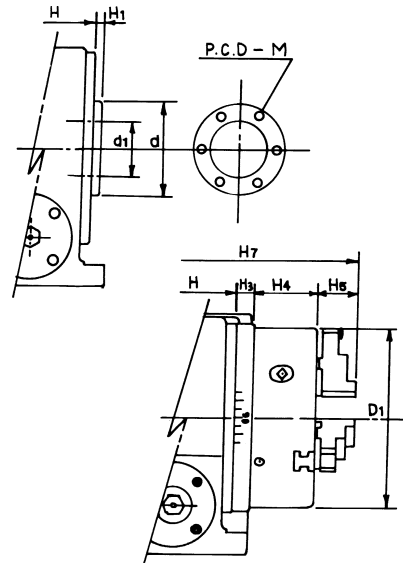

Spindle & chuck specifications

Inch/(mm)

Inner Jaw	Outer Jaw	I.D.
0.12 - 1.18 (3 - 30)	0.12 - 3.31 (3 - 86)	1.26 (32)
0.16 - 1.65 (4 - 42)	0.39 - 6.14 (10 - 156)	1.73 (44)
0.16 - 2.44 (4 - 62)	0.39 - 7.09 (10 - 180)	2.48 (63)
0.16 - 3.46 (4 - 88)	0.47 - 9.06 (12 - 230)	3.54 (90)
0.20 - 4.25 (5 - 108)	0.59 - 10.43 (15 - 265)	4.33 (110)
1.57 - 13.31 (40 - 128)	2.13 - 13.31 (54 - 338)	5.12 (130)