

YUASA International

OPERATION AND SERVICE MANUAL

**SUPER-SPACER/
SIMPLE INDEXING
SPACER**

YSS-9401H

CS

Super-Spacer

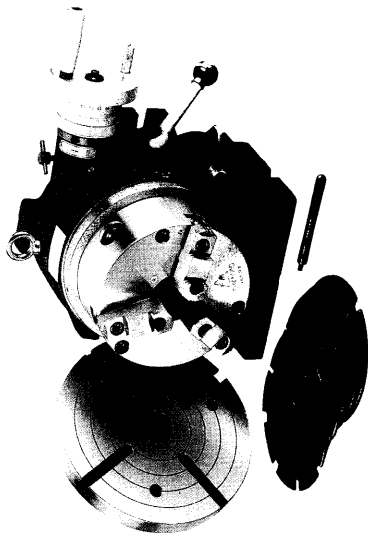

This super index serves as a multi-purpose dividing attachment in use for milling machines, drilling machines and other metalcutting machine tools. The unit will perform not only single-purpose indexing but various indirect indexing jobs with proper use of worm gear techniques. Therefore it is widely used for circumferential cutting, angular indexing, drilling, facing operations, etc., in the metalworking industry.

Handling and Maintenance

This machine is built to very rigorous tolerances, and the internal mechanism is so designed as to completely prevent debris, such as chips, cast iron dust or grit from entering the inside.

Standard Accessories

1. Face plate 1 pc
2. Masking plate (tooth numbers 2, 3, 4, 6, 8, and 12) 1 each

Optional Accessories

1. Dividing plates
2. Tail Stock
3. Scroll Chuck

Specifications:

Master index plate

The single-purpose master index plate is being divided into 24 equal parts and indexing positions, 2, 3, 4, 6, 8, 12 and 24 can be readily obtained with the aid of a mask plate in an easy manner so that there is no operational error at all.

As for its mechanism, refer to Page 3 in this manual

Worm gear ratio

The worm gear ratio for indirect indexing is 1:90.

Collar Reading

The collar Reading of the index handle is 1° per division, which is readable up to 10' with the use of the vernier scale.

Scroll chuck

This special adjustable type scroll chuck provided with a 2-piece interchangeable jaw mechanism will largely facilitate centering work. In addition, if this unit is equipped with an optional 10" (254mm) diameter face plate after removing this chuck, it will become a rotary table capable of both horizontal and vertical applications in common.

Dimensional drawing.

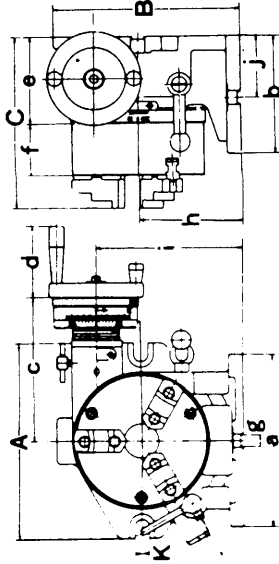

Order No. & Dimensions

Order No.	Items	Numbers of dividing	Chuck				Face plate		Weight kg/lb
			Outer diameter	Inner jaw	Outer jaw	Inner dia	Outer diameter	Thickness	
595-666	CS-6	2 • 3 • 4 • 6	167	4-42	10-156	44	203	50	18
595-008	CS-8	8 • 12 • 24	210	4-62	10-180	63	254	58	18

Unit: mm/in

***Suggestions for ordering**

The parts No. & parts names expressed in the operation and service manual are abbreviated for description.

Therefore, when ordering parts for replacement, be sure to specify stock Nos. and component Nos., which are shown in the table of Part No. and Part Names.

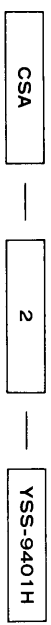

(N. B.) When ordering parts in accordance with the exploded view No. and the like given in the catalog of a single product or all products, be sure to write in addition its page so as to distinguish from the Operation and Service Manual No.

● Sectional Drawing

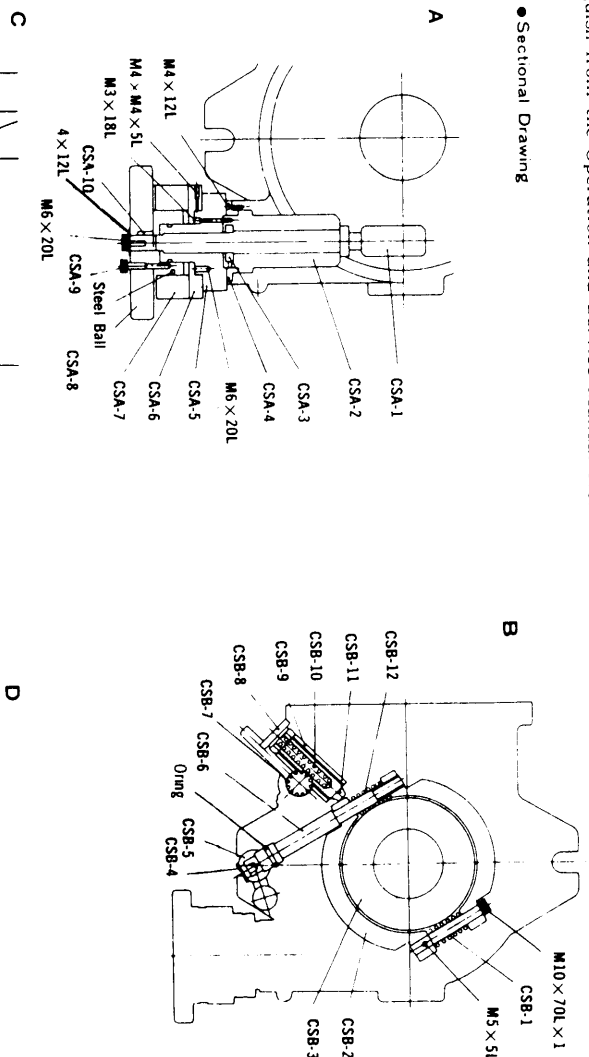

Part No.	Part Names
CSA-2	Worm metal
CSA-3	Nut for worm shaft
CSA-4	Metal thrust plate
CSA-5	Switch metal
CSA-6	Vernier ring
CSA-7	Micro-Collar
CSA-8	Wheel handle
CSA-9	Micro-Collar pusher screw
M3×18L	For switch metal 3 pcs
M4×5L	For vernier ring 1 pc
M4×12L	For metal thrust plate 4 pcs
M6×20L	Washer for handle 1 pc
4×12L	Worm shaft key
CSB-4	Bush
CSB-8	Index pin cover
CSB-10	Index pin spring
CSB-11	Index pin
CSB-12	Clamp shoe spring
M5×5L	Set-screw (for clamp shoe) 1 pc
M10×70L	Bolt (for clamp shoe) 1 pc
CSC-1	Index pin cover
CSC-2	Pinion shaft
M6×18L	For pinion shaft
CSD-1	Turret
CSD-2	Clamp shoe
CSD-3	Worm wheel
CSD-4	Worm shaft.
CSD-5	Master index plate
CSD-6	Mask Plate
CSD-7	Thrust plate
CSD-8	Body
M8×45	(Bolts for master index and wheel clamping)

Operating Instructions and Functions of Each Unit

Single-purpose indexing mechanism

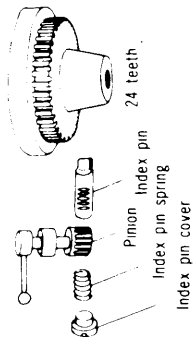

Fig. 1

This indexing mechanism is so designed as to cause the index pin to be inserted in its indexing position (groove) on the master index plate by means of the rack gearing, and the strength of a spring that pushes the index pin may be microadjusted with the cap index pin cover used. (Fig. 1)

Hints on operation

When the single-purpose indexing is carried out, that worm gears must always be disengaged without fail.

(Example) In case of trisection by means of the singlepurpose indexing method.

1. First, release the worm gear from engagement. Loosen the metal clamp handle CT-11 first and rotate the switch metal 9 clockwise until it hits the stopper so that the worm gear completely disengages from the worm wheel. In this case, the handle must be very tight while locating in neutral, to protect the worm gear from damage. The chuck can be rotated by hand in neutral. (Fig. 2)

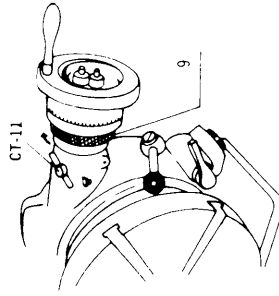

Fig.

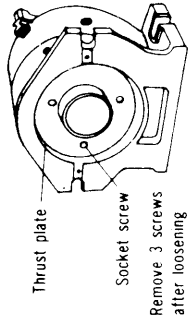

Fig. 3

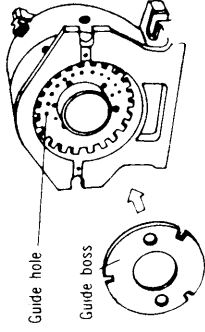

Fig. 4

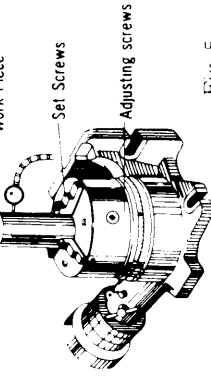

Fig. 5

3. In this time, if centering of the chuck is not correctly conducted, it will adversely affect the indexing accuracy. Be sure to perform centering operation with careful attention. Each time the chuck is removed from the unit, it must be recentered. Under no circumstances must this procedure be omitted. (Shown page 6)

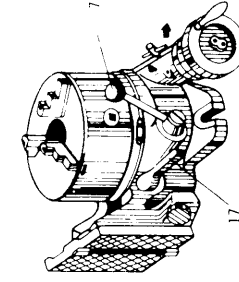

Fig. 6

4. In the indexing procedures, first lay down the clamp handle 7 to the left, unclamp the table, pull the pinion handle 17 toward yourself, and remove the index pin 14 from its position (groove). Then press the handle 17 downward (Figure 7 on Page 4).

5. While the pinion shaft 16 is pressed down in this way, the head of set-screw (C) consequently enters into the pinion shaft, whereupon the shaft 16 no longer rotates. At that time, the index pin 14 will remain in a state where it has been pulled out of a groove on the master index plate.

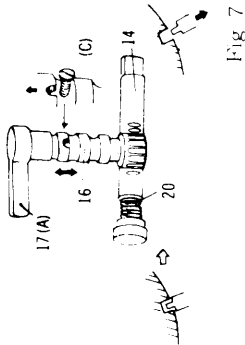

Fig. 7

6. Next, after slightly rotating the chuck, raise the handle 17 upward and if you continue to rotate the chuck, the index pin 14 will automatically fall in the next position (groove). When your hand is off the handle 17, it will be immediately restored to its original state through the resilient force by spring.

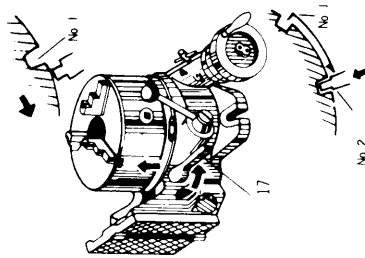

Fig. 8

7. Now we are getting through the course of indexing operation. Before we enter the next course of machining, the following procedures must be observed.

1. Lay down the clamp handle 7 to the right.
2. Have the clamp shoe 3 clamp the turret 2.
3. Chuck the workpiece exerting tight pressure.

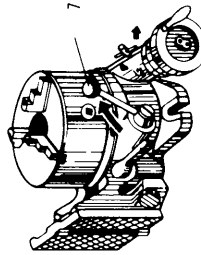

Fig. 9

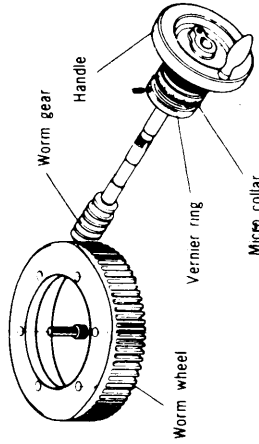

Fig. 10

Indirect Indexing Mechanism

As shown in Fig. 10, useage of both the worm wheel and the worm gear, (worm ratio 1 : 90) Will assure on accurate indexing operation may be assured. Rotate the wheel handle 15 one revolution, the worm wheel will rotate 1/90 of a revolution.

The workpiece is on the same shaft mounting and consequently will rotate by a 1/90 of a revolution as well. 90 rotation of the handle will turn the workpiece on full 360° revolution.

Hints on operation

In case of indexing operation by the worm gear mechanism, pull out the index pin from the master index plate, depress the indexing pinion handle 17, and keep a state where the index pin is being removed from the master index plate without fail. (Refer to Par. 5 in "Single-Purpose Indexing" on Page 3.)

(Example 1)

Drilling 18 holes on the circumference of the workpiece at equal intervals. The relationships between the dividural number 'T' to be sought and the number of handle revolution 'N' may be expressed with the following equation.

$$N = \frac{90}{T} \rightarrow N = \frac{90}{18} = \frac{45}{9} = 5$$

That is to say, when the operator starts drilling operation Drilling after 5 rotation of the handle in succession and repeating this procedures as many as 18 times. Will completed the 18-hole drilling operation.

(Example 2)

To drill hole at $20^{\circ} 1' 30''$ in the angle of center from a hole on the circumference of the workpiece.

When it is necessary to have an angle of a fractional revolution less than one revolution of the handle, like a concept of dividing into equal parts as in case of a worm ratio 1 : 90, the chuck is to rotate a full .360 round per revolution every 90 turns. This theory may be expressed by the following equation.

$$N = \text{Handle revolution required} \quad \alpha = \text{Angle}$$

$$N = \frac{\alpha}{4} \quad (\text{Provided } \frac{360}{90} = 4)$$

then $20^{\circ} 1' 30''$ is

$$N = (\frac{20}{4}) + 1 = 30$$

or after proving the given 20 by rotating the handle five times, a minimal revolution should be further give to the handle while reading 1 with the use of the Micro collar and 30 with the vernier scale.

How To Adjust

1. Worm Gearing Adjustment

On rotating the switch metal 09 clockwise until it hits the stopper after loosening the metal clamp handle, the worm gear will become free from engagement.

Conversely, when the switch metal is made to rotate until it hits the stopper, the worm gear engage to engagement. In case where the depth of the gear engagement is shallow, remove the screw A and the steel ball and rotate the screw B inside the unit counterclockwise so that the gear engagement proportionately becomes deepened. Reversely, when the screw B is made to rotate clockwise, the depth of engagement will proportionately become shallow.

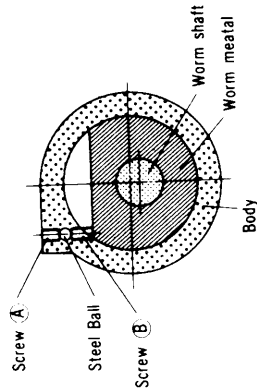

Fig. 11

After adjustments are over, replace the steel ball and clamp the screw A tight with the metal clamp handle tightened. (Fig. 11)

2. Worm Shaft Direction Adjustment

When looseness in the axial direction of the worm shaft has been found, remove the handle 15, vernier ring 10 and switch metal 09, and then tighten the worm shaft nut 7 housed inside so that the looseness will be adjusted. After adjustment, do not forget to use a stopper for nut rotations. (Refer to Fig. 12 and sectional Drawing Page 2).

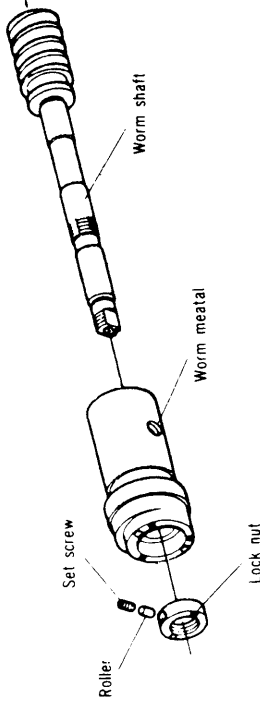

Fig. 12

3. Brake Handle Position Adjustment

When there is something wrong as the position of the brake handle 7 hits the machine proper, remove the set-screw 13, pull out the handle knob section alone because of its serration construction, then reinsert it along the groove after slightly moving its angle, and reclamp with the setscrew. (Refer to Fig. 14 and Page 2)

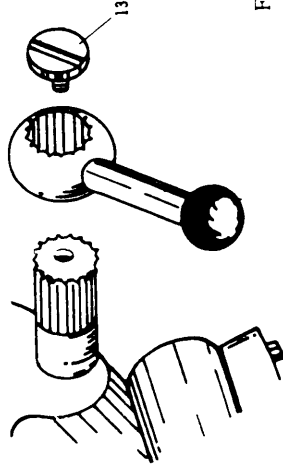
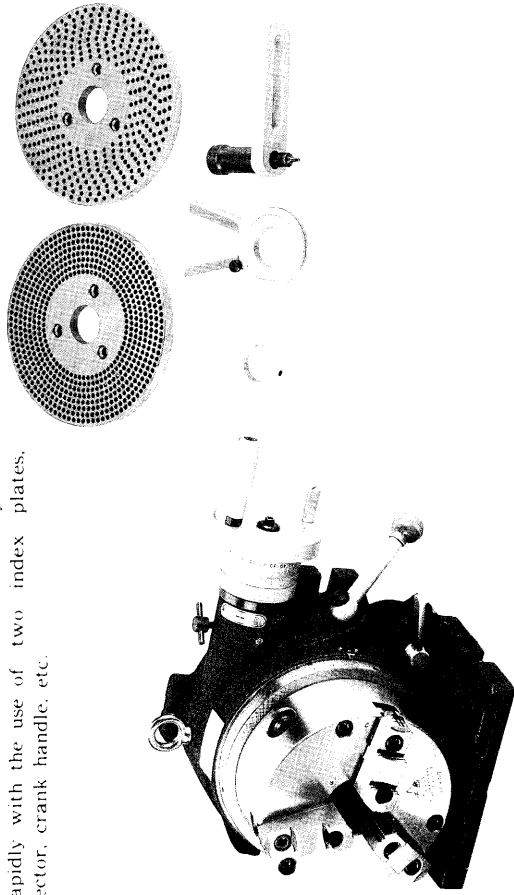

Fig. 13

DP-5 Dividing Plates Device: 599-007

When using the Dividing plates (Dividing Mechanism) device, the indexing of 2 to 100 positions can be carried out accurately and rapidly with the use of two index plates, sector, crank handle, etc.



Dividing Plates Principal Dimensions

Order No.	Item	Dividing plate set-screw	Index plate O.D.	Sector I.D.	Sector spring O.D.	Handle plate groove width	Handle plate length	Weight kg/Lb
599-007	DP-5	M6×3 PCD1.65	185 7.28	28.7 1.13	44 1.73	10 0.39		4 8.82

Unit: mm/in

Dividing Plate Hole Numbers (for worm gear ratio 1:90)

Number of holes	A plate	B plate
	26, 28, 30, 32, 34, 37, 38, 39, 41, 43, 44, 46, 47, 49, 51, 53, 57, 59,	61, 63, 67, 69, 71, 73, 77, 79, 81, 83, 87, 89, 91, 93, 97, 99,

Special Accessories on order

Dividing plate for specific hole number, which can index more than 100 positions.

Master index plate producing 20-, 30-tooth types, etc.

In case of 20-tooth type: 2, 4, 5, 10 and 20 available.

In case of 30-tooth type: 2, 3, 5, 6, 10, 15 and 30 available.

Specially Designed Chuck and Jaws

The chuck available consists of two-piece jaw (two-step interchangeable type). By moving jaws sideways after removing the bolt, they can easily be taken out.

Method of Centering

While holding the test bar or workpiece, put a dial gauge to its circumference to read the run-out.

Loosen the three chuck mounting bolts and adjust the run-out to become zero on the dial gauge by using three additional adjusting bolts.

After the run-out has become zero, tighten the three chuck mounting bolts then fix the chuck to the turret by tightening these bolts.

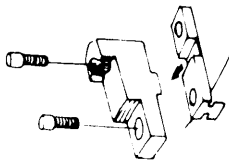

Fig 14

Optional Accessories

Tailstocks (TS-2R): 599-301

In case where the machine proper is set down on a vertical type, accurate centering operation can be made in combination with this tailstock.

The direction of centering is provided with a right-hand type.

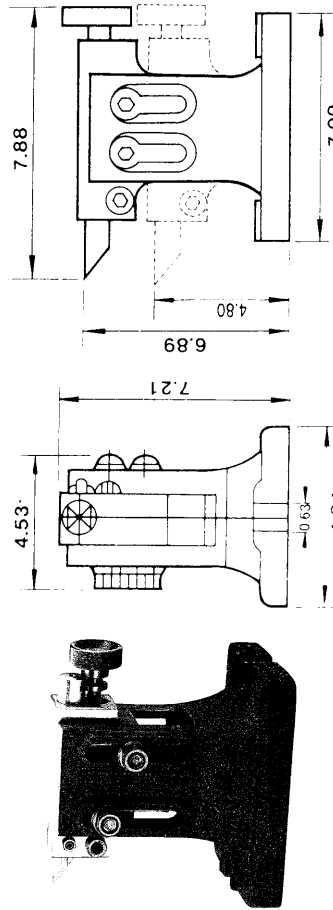

Fig 15

When the Optional Dividing plates are used

Indexing of 2 to 100 can be made accurately and quickly.

Equation of Indexing

Since the worm ratio is 1:90, when the handle is made to rotate one 360° revolution, the table therefore will rotate a 1/90 revolution. The relationships between handle revolution N and dividural number T to be sought are shown in the following equation:

$$N = \frac{90}{T}$$

Remarks: The index table on Page 8 is made on the basis of this equation.

(Example)

In case where the operator wants to index the position divided into 29 equal parts.

As for 29 dividural numbers, the number of crank handle revolutions (N) is 3 $\frac{1}{3}$ as shown in the table on Page 8, so that the handle should be rotated a full 360° revolution three times plus an interval of nine holes (in this time, this means hole intervals not hole numbers). After setting this point as a start point, rotate the handle a full 360° revolution three times plus an interval of nine holes.

When the procedure is repeated in turn as many as 29 times, the indexing of dividing into 29 equal parts is thus achieved.

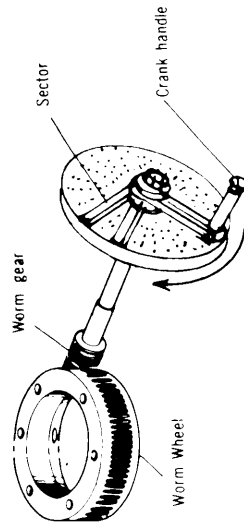

Fig. 16

Hints on operation

In case of indexing operation by the worm gear mechanism, pull out the index pin from the master index plate, depress the indexing pinion handle 17, and keep a state where the index pin is being removed from the master index plate without fail. (Refer to Par. 5 in "Single-Purpose Indexing" on Page 3.)

Operations of Crank Handle and Sector

In case of the Example 'Division into 29 Equal Parts' aforesaid, it is natural that indexing operation should proceed with the intervals of nine holes after setting the index plate (B plate) on which a row of 87 holes are provided. But in this method, the operator has to count nine holes' intervals one by one. It is there fore necessary to use a device called 'sector' to avoid such trouble some procedures.

The following will describe some necessary procedures for operation of the sector.

- Loosen the crank handle lock nut, adjust its length so as to cause the index pin to fall in the train of 87 holes, and retighten it.
 - Loosen the set-screws of the sector, open two arms in accordance with the interval of nine holes (total numbers of holes are ten), and retighten with set-screws.
 - First, bring the left arm of the sector near to the index pin's left side.
 - Next, rotate the crank handle clockwise to apply it to the right arm of the sector so that the index pin will fall in the hole located at this right arm's left side surface.
 - Rotate the sector clockwise this time, and put the right side surface of the left arm to the left side of the index pin. In this time, the relationships between the index pin and the sector's left arm in their positions are the same as in Par. c).
- The index plate hole that actually accommodates the index pin is located at the point where goes across ten holes to the right away from the hole as in Par. c).
- Repeat the same procedures as necessary.

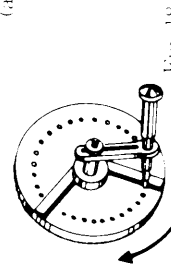

(c)

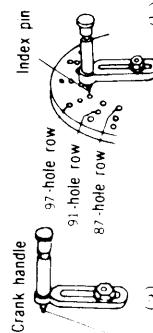

Fig. 18

(d)

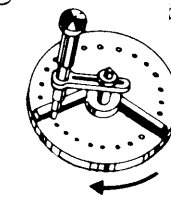

Fig. 19

(e)

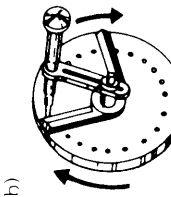

Fig. 20

(f)

Fig. 17

(h)

(g)

Index Table (For worm ratio 1:90)

T	H	N	T	H	N	T	H	N	T	H	N	T	H	N	T	H	N					
2	*	45	17	A-34	5	10/34	32	A-32	2	26/32	48	A-32	1	28/32	65	B-91	1	35/91	81	B-81	1	9/81
3	*	30	18	*	5		33	B-99	2	72/99	49	A-49	1	41/49	66	A-44	1	16/44	82	A-41	1	4/41
4	A-26	22	13/26	A-38	4	28/38	34	A-34	2	22/34	50	A-30	1	24/30	67	B-99	1	36/99	83	B-83	1	7/83
5	A-28	22	14/28	A-26	4	13/26	35	A-28	2	16/28	51	A-34	1	26/34	68	B-67	1	23/67	84	A-28	1	2/28
6	*	18		A-28	4	14/28		B-63	2	36/63	52	A-26	1	19/26	69	A-34	1	11/34	85	A-34	1	2/34
7	A-28	12	24/28	A-28	4	8/28	36	A-26	2	13/26	53	A-53	1	37/53	70	A-46	1	14/46	86	A-43	1	2/43
8	B-77	12	66/77	B-77	4	22/77	37	A-30	1	20/30	54	A-30	1	28/44	71	B-69	1	21/69	87	B-87	1	3/87
9	A-28	11	7/28	A-44	4	4/44	38	A-37	2	16/37	55	B-63	1	42/63	72	A-28	1	8/28	88	A-44	1	1/44
10	A-44	11	11/44	B-77	4	7/77	39	A-44	1	28/44	56	A-44	1	28/44	73	B-63	1	18/63	89	B-89	1	1/89
11	*	10		A-46	3	42/46	40	A-26	2	8/26	57	B-77	1	49/77	74	B-71	1	19/71	90	*	1	
12	A-26	8	8/44	B-69	3	63/69	41	B-91	2	28/91	58	A-28	1	17/28	75	A-32	1	8/32	91	B-91		90/91
13	B-77	8	14/77	A-28	3	21/28	42	A-28	2	7/28	59	A-38	1	22/38	76	A-44	1	11/44	92	A-46		45/46
14	A-26	7	13/26	A-44	3	33/44	43	A-44	2	11/44	60	B-87	1	48/87	77	B-73	1	17/73	93	B-93		90/93
15	A-28	7	14/28	A-30	3	18/30	44	A-41	2	8/41	61	A-59	1	31/59	78	A-37	1	8/37	94	A-47		45/47
16	A-26	6	24/26	A-26	3	12/26	45	A-28	2	4/28	62	A-34	1	17/34	79	A-30	1	6/30	95	A-38		36/38
17	B-91	6	84/91	B-91	3	42/91	46	B-63	2	9/63	63	A-32	1	16/32	80	A-38	1	7/38	96	A-32		30/32
18	A-28	6	12/28	A-30	3	10/30	47	A-43	2	4/43	64	B-61	1	29/61	81	B-77	1	13/77	97	B-97		90/97
19	B-77	6	33/77	B-63	3	21/63	48	A-44	2	2/44	65	B-93	1	42/93	82	A-39	1	6/39	98	A-49		45/49
20	*	6		A-28	3	6/28	49	*	2		66	A-49	1	21/49	83	B-91	1	14/91	99	A-44		40/44
21	A-32	5	20/32	B-87	3	9/87	50	A-46	1	44/46	67	B-77	1	33/77	84	B-79	1	11/79	100	B-99		90/99
22	A-32	5	20/32	*	3		51	B-69	1	66/69	68	A-32	1	13/32	85	A-32	1	4/32	100	A-30		27/30
23	A-32	5	20/32	B-93	2	84/93	52	A-47	1	43/47	69	A-26	1	10/26	86	B-63	1	7/63				

Description of in the index table.

This table is the one being calculated for the index plate with hole numbers shown below.

Description of codes used in the index table.

- T : Desired dividural number
- N : Number of revolution of the crank handle
- H : Hole number of the index plate
- * : Option
- A : Using A plate
- B : Using B plate

Number of holes

- A Plate---26, 28, 30, 32, 34, 37, 38, 39, 41, 43, 44, 46, 47, 49, 51, 53, 57, 59
- B Plate---61, 63, 67, 69, 71, 73, 77, 79, 81, 83, 87, 89, 91, 93, 97, 99

(I) Formula

The turning ratio of the table to the handle is 1 : 90
Namely the table turns 1/90 rotation
by a full rotation of the handle.

$$N \frac{90}{T}$$

(II) Example: Divide into 48.

$$N \frac{90}{48}$$

$$= 1 \frac{42}{48} = 1 \frac{7}{8} = 1 \frac{7 \times 4}{8 \times 4}$$

$$= 1 \frac{28}{32}$$

Remarks T : Nos. of Division

N : Rotation of Crank

H : Holes of dividing Plate

* : Free choice

A : Plate-A type should be used

B : Plate-B type should be used

SIMPLE INDEXING SPACER 595-006/007

CONSTRUCTIONAL DRAWING

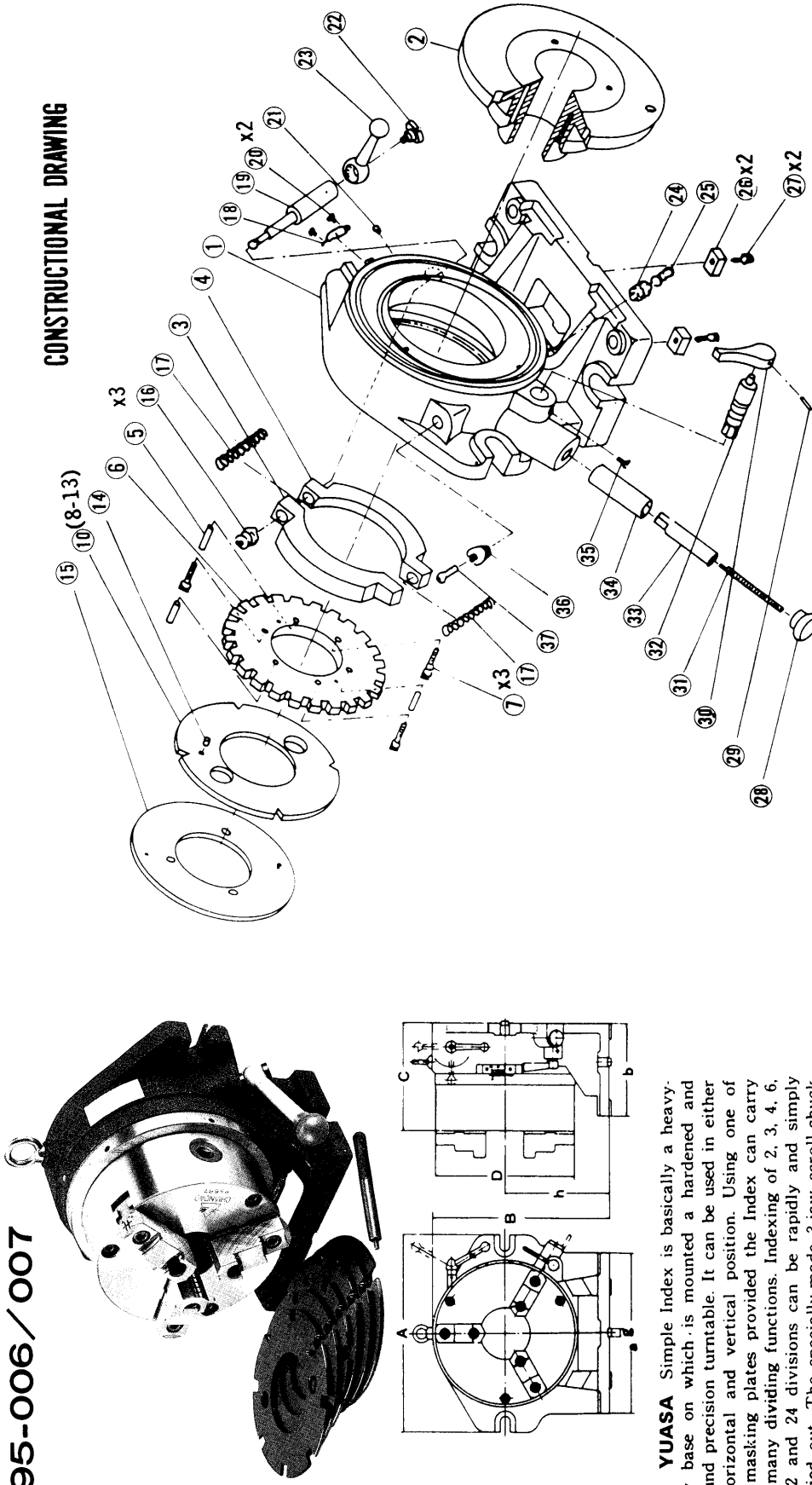

The **YUASA** Simple Index is basically a heavy-duty base on which is mounted a hardened and ground precision turntable. It can be used in either a horizontal and vertical position. Using one of the masking plates provided the Index can carry out many dividing functions. Indexing of 2, 3, 4, 6, 8, 12 and 24 divisions can be rapidly and simply carried out. The specially-made 3-jaw scroll-chuck also simplifies the indexing of long workpieces.

Order No & Dimensions

Order No.	Items	Dividual number	A	B	C	D	a	b	h	Inner jaw	Guide block	Outer jaw	Diameter of hole(chuck) hole(turret)	Diameter of	Net weight
595-006	CC-6	2 • 3 • 4 • 6	260	218	156.2	167	220	130	1.30	4 ~ 42	16	10 ~ 156	44	36	32.5
595-007	CC-8	8 • 12 • 24	312	257	173.3	210	258	148	149.25	4 ~ 62	16	10 ~ 180	63	63	50.0

Unit: mm/in